

SMALL CENTRIFUGES

EBA 280 | 280 S

SIMPLE ROTOR CHANGE FOR GREATER VERSATILITY

The EBA 280 and EBA 280 S offer exceptional user comfort and a choice of 6 rotors. The rotor can be removed and replaced easily thanks to the quick release system. The rotor locks in place and remains secure without the use of tools or extra effort. The backlit digital control panel offers the opportunity to save multiple program settings.



HIGHLIGHTS

- RPM: 200 - 6,000 min⁻¹
Adjustable in increments of 10
- max. RCF: 4,146 | 5,071
- max. capacity: 6 x 50 ml
- small centrifuge with rapid rotor change system
- Choice of 6 rotors
- IVDR-conform according to regulation (EU) 2017/746
- maximum noise level of ≤ 51 dB(A) | ≤ 56 dB(A)
- impulse key for short cycle mode
- 9 individual acceleration and deceleration stages
- easy operation with keypad
- 9 programmable memory settings

FEATURES

- plastic housing
- metal lid
- viewing port in the lid
- one-hand lid lock
- lid dropping protection
- emergency lid lock release
- stainless steel chamber
- automatic rotor recognition
- brushless drive
- error display
- imbalance monitoring and switch-off
- backlit panel with actual values of all parameters
- 3 adjustable messages after completion of the centrifugation run (audio + visual)

TECHNICAL DATA

	EBA 280	EBA 280 S
voltage *)	200 – 240 V 1 ~	200 – 240 V 1 ~
frequency	50 – 60 Hz	50 – 60 Hz
consumption	185 VA	330 VA
emission, immunity	EN/IEC 61326-1, class B	EN/IEC 61326-1, class B
max. capacity	6 x 50 ml	6 x 50 ml
max. RPM	6,000 min ⁻¹	6,000 min ⁻¹
max. RCF	4,146	5,071
running time	1 – 99 min: 59 sec, y continuous run, short cycle mode (impulse button)	1 – 99 min: 59 sec, y continuous run, short cycle mode (impulse button)
dimensions (WxDxH)	326 x 400 x 242 mm	326 x 400 x 242 mm
weight	approx. 12 kg	approx. 12 kg
noise level	≤ 47 dB (A) with rotor 1137	≤ 50 dB (A) with rotor 1137
Cat. No.	1101	1102

100 – 127 V 1 ~ / 50–60 Hz

1101-01

1102-01

emission, immunity

FCC class B

FCC class B



*) Other voltages on request.

AVAILABLE ROTORS

SWING-OUT ROTORS

	angle	max. RPM	max. capacity	Cat. No.	page
 swing-out rotor, 6-place	90°	6,000 min ⁻¹	6 x 15 ml	1146	3
 swing-out rotor, 8-place	90°	5,000 min ⁻¹	8 x 10 ml	1148	4
 swing-out rotor, 12-place	60°	5,000 min ⁻¹	12 x 5 ml	1142	4

ANGLE ROTORS

 angle rotor, 6-place	35°	6,000 min ⁻¹	6 x 50 ml	1137	5
 angle rotor, 12-place	35°	5,000 min ⁻¹	12 x 7 ml	1133	5
 angle rotor, 12-place	35°	6,000 min ⁻¹	12 x 15 ml	1139	6

SWING-OUT ROTOR, 6-PLACE | 1146



Rotor	
max. RPM	EBA 280 EBA 280 S
max. RCF	4,700 min ⁻¹ 6,000 min ⁻¹
max. capacity	3,112 5,071
run up / run down, braked in sec	6 x 15 ml
angle max. noise level	9 / 11 11 / 13
	90° 49 dB (A)
Cat. No.	1146

Bucket	
Cat. No.	1147-6 (6 pcs.)

Vessels															
capacity in ml	0.5	1.5	2	4	5	6	15	1.1-1.4	2.6-3.4	2.7-3	4-5.5	4.5-5	4.9	7.5-10	1.6-5
Ø x L in mm	10.7x46	11 x 38	11 x 38	10x88	12x75	12x82	17x100	8x66	13x65	11x66	15x75	11x92	13x90	15/16x92	13x75
max. RCF ²⁾	EBA 280	1,877	1,902	1,902	3,112	2,618	2,865	3,112	2,618	2,618	3,112	3,112	3,112	3,112	2,618
max. RCF ²⁾	EBA 280 S	3,059	3,099	3,099	5,071	4,266	4,669	5,071	4,266	4,266	4,266	5,071	5,071	5,071	4,266
radius in mm	76	77	77	126	106	116	126	106	106	106	126	126	126	126	106
Cat. No.	Pediatric	microliter tubes			tubes²⁾			blood collection / urine tubes							

Adapter															
boring Ø x L in mm	11 x 35	11 x 35	11 x 35	17.5x80	13.5x59	17.5x80	17.5x80	13.5x59	13.5x59	13.5x59	17.5x80	17.5x80	17.5x80	17.5x80	13.5x59
vessels per rotor	6	6	6	6	6	6	6	6	6	6	6	6	6	6	6
Cat. No.	1063-6 (6 pcs.)			-	1053-6	0767-6	-	1053-6 (6 pcs.)			-	-	-	-	1053-6

Vessels				
capacity in ml	4-7	4-7	8.5-10	12
Ø x L in mm	16x75	13x100	16 x 100	17x102
max. RCF ²⁾	EBA 280	2,865	3,112	3,112
max. RCF ²⁾	EBA 280 S	4,669	5,071	5,071
radius in mm	116	126	126	126
Cat. No.	blood collection/urine tubes			

Adapter				
boring Ø x L in mm	17.5x80	13.5x79	17.5x80	17.5x80
vessels per rotor	6	6	6	6
Cat. No.	0767-6	1058	-	-

2) Please note that the RCF values indicated refer only to rotor performance. The max. permissible RCF of tubes used should be verified with the individual manufacturers. The max. RCF for glass tubes annotated with footnote 2) is 4,000.

— SWING-OUT ROTOR, 8-PLACE | 1148



Rotor

max. RPM max. RCF	5,000 min ⁻¹ 2,991
max. capacity	8 x 10 ml
run up run down, braked in sec	8 10
angle max. noise level	90° 50 dB (A)
Cat. No.	1148



Vessels

capacity in ml	5	6	10	2.6–3.4	2.7–3	4–5.5	1.6–5	4–7
Ø x L in mm	12 x 75	12 x 82	17 x 70	13 x 65	11 x 66	15 x 75	13 x 75	16 x 75
max. RCF ²⁾	2,991	2,991	2,991	2,991	2,991	2,991	2,991	2,991
radius in mm	107	107	107	107	107	107	107	107
Cat. No.	tubes²⁾			blood collection / urine tubes				



Bucket

boring Ø x L in mm	13 x 53	13 x 53	17.5 x 53	13 x 53	13 x 53	17.5 x 53	13 x 53	17.5 x 53
vessels per rotor	8	8	8	8	8	8	8	8
Cat. No.	1131-A	1131-A	1132-A	1131-A	1131-A	1132-A	1131-A	1132-A

— SWING-OUT ROTOR, 12-PLACE | 1142



Rotor

max. RPM max. RCF	5,000 min ⁻¹ 2,963
max. capacity	12 x 5 ml
run up run down, braked in sec	10 12
angle max. noise level	60° 49 dB (A)
Cat. No.	1142



Vessels

capacity in ml	5	2.6–3.4	2.7–3	1.6–5
Ø x L in mm	13 x 75	13 x 65	11 x 66	13 x 75
max. RCF ²⁾	2,963	2,963	2,963	2,963
radius in mm	106	106	106	106
Cat. No.	tube²⁾	blood collection / urine tubes		



Bucket

boring Ø x L in mm	13.2 x 53	13.2 x 53	13.2 x 53	13.2 x 53
vessels per rotor	12	12	12	12
Cat. No.	1127-A	1127-A	1127-A	1127-A

2) Please note that the RCF values indicated refer only to rotor performance. The max. permissible RCF of tubes used should be verified with the individual manufacturers. The max. RCF for glass tubes annotated with footnote 2) is 4,000.

— ANGLE ROTOR, 6-PLACE | 1137



Rotor

max. RPM max. RCF	6,000 min ⁻¹ 4,025
max. capacity	6 x 50 ml
run up run down, braked in sec	20 17
angle max. noise level	35° 47 dB (A)
Cat. No.	1137



Vessels

capacity in ml	7	15	25	50	9-10	10	1.6-5	4-7	15	50	30	50
Ø x L in mm	12 x 100	17 x 100	24 x 100	34 x 100	16 x 92	15 x 102	13 x 75	13 x 100	17 x 120	29 x 115	26 x 95	29 x 107
max. RCF ²⁾	3,944	3,783	3,703	4,025	3,783	3,783	2,978	3,783	3,824	3,824	3,703	3,904
radius in mm	98	94	92	100	94	94	74	94	95	95	92	97
Cat. No.	tubes²⁾				blood collection / urine tubes				tubes with screw cap			



Adapter

boring Ø x L in mm	13 x 92	17.5 x 95	26 x 88	35 x 96	17.5 x 95	17.5 x 95	17.5 x 95	17.5 x 95	17 x 98	30 x 98	26 x 88	29 x 95
vessels per rotor	18	6	6	6	6	6	6	6	6	3	6	6
Cat. No.	1632	1635	1633	-	1635	1635	1635	1635	1631	1641	1633	1634

— ANGLE ROTOR, 12-PLACE | 1133

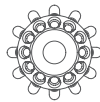

Rotor

max. RPM max. RCF	5,000 min ⁻¹ 2,879
max. capacity	12 x 7 ml
run up run down, braked in sec	8 10
angle max. noise level	35° 51 dB (A)
Cat. No.	1133



Vessels

capacity in ml	5	6	7
Ø x L in mm	12 x 75	12 x 82	12 x 100
max. RCF ²⁾	2,879	2,879	2,879
radius in mm	103	103	103
Cat. No.	tubes²⁾		



Adapter

boring Ø x L in mm	12.5 x 66	12.5 x 66	12.5 x 66
vessels per rotor	12	12	12
Cat. No.	-	-	-

What makes the 1133 rotor special is its adapters with a decanting aid. The decanting aid firmly holds the tube and keeps it from falling out when the supernatant is decanted. The 1133 rotor is often used in blood typing serology.

2) Please note that the RCF values indicated refer only to rotor performance. The max. permissible RCF of tubes used should be verified with the individual manufacturers. The max. RCF for glass tubes annotated with footnote 2) is 4,000.

— ANGLE ROTOR, 12-PLACE | 1139

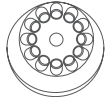

Rotor

max. RPM max. RCF	6,000 min ⁻¹ 4,146
max. capacity	12 x 15 ml
run up run down, braked in sec	16 16
angle max. noise level	35° 50 dB (A)
Cat. No.	1139

Vessels

capacity in ml	0.5	1.5	2	4	5	6	15	1.1-1.4	2.6-3.4	2.7-3	4.5-5	4.9	7.5-10	10	1.6-5	
Ø x L in mm	10.7 x 46	11 x 38	11 x 38	10 x 88	12 x 75	12 x 82	17 x 100	8 x 66	13 x 65	11 x 66	11 x 92	13 x 90	15/16 x 92	15 x 102	13 x 75	
max. RCF ²⁾	2,777	2,737	2,737	3,300	3,300	3,300	4,146	3,300	3,300	3,300	4,146	4,146	4,146	4,146	3,300	
radius in mm	69	68	68	82	82	82	103	82	82	82	103	103	103	103	82	
Cat. No.	Pediatric	microliter tubes			tubes²⁾			blood collection / urine tubes								



Adapter

boring Ø x L in mm	11 x 35	11 x 35	11 x 35	11,5 x 67,5	13,5 x 60	13,5 x 60	17,7 x 88	13,5 x 60	13,5 x 60	13,5 x 60	13,5 x 60	13,5 x 60	13,5 x 60	17,7 x 88	17,7 x 88	13,5 x 60
vessels per rotor	12	12	12	12	12	12	12	12	12	12	12	12	12	12	12	12
Cat. No.	1063-6 (6 uds.)			6305	1054-A	1054-A	-	1054-A	1054-A	1054-A	1054-A	1054-A	1054-A	-	-	1054-A

Vessels

capacity in ml	4-7	8	8.5-10	12	15
Ø x L in mm	13 x 100	16 x 125	16 x 100	17 x 102	17 x 120
max. RCF ²⁾	4,146	4,146	4,146	4,146	4,146
radius in mm	103	103	103	103	103
Cat. No.	blood collection / urine tubes				-



Adapter

boring Ø x L in mm	13.5 x 79	17.7 x 88	17.7 x 88	13.5 x 60	17.7 x 88
vessels per rotor	12	6	12	12	6
Cat. No.	1058	-	-	1054-A	-

2) Please note that the RCF values indicated refer only to rotor performance. The max. permissible RCF of tubes used should be verified with the individual manufacturers. The max. RCF for glass tubes annotated with footnote 2) is 4,000.

CERTIFICATIONS / REGISTRATIONS

Product certification:



Product registration:



according to regulation (EU) 2017/746

Company certifications:



DIMENSIONS – EBA 280 | 280 S

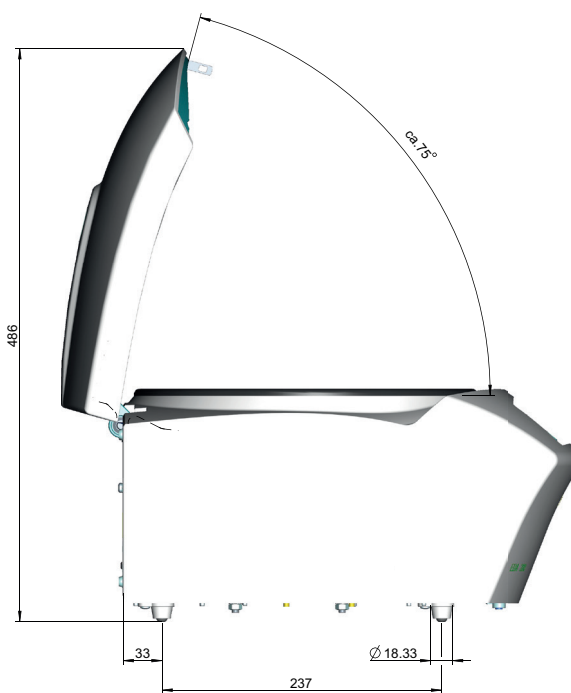
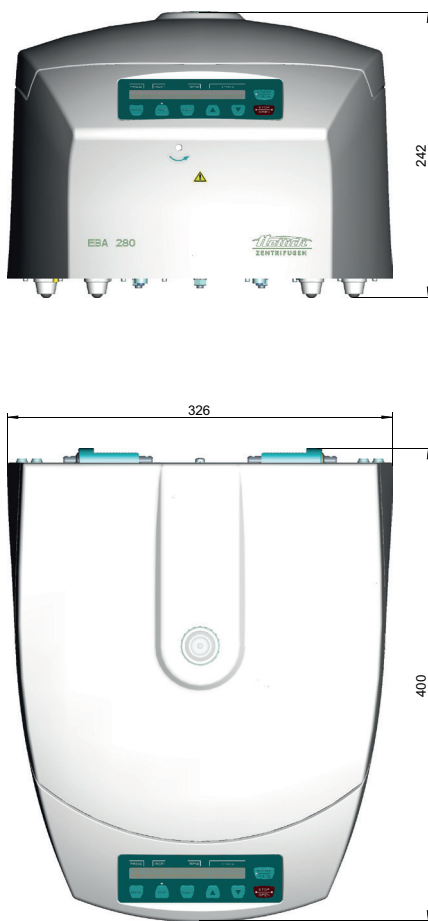



WolfLabs

Pricing on any accessories shown can be found by keying the part number into the search box on our website.

The specifications listed in this brochure are subject to change by the manufacturer and therefore cannot be guaranteed to be correct. If there are aspects of the specification that must be guaranteed, please provide these to our sales team so that details can be confirmed.

www.wolflabs.co.uk

Tel : 01759 301142

Fax : 01759 301143

sales@wolflabs.co.uk

Please contact us if this literature doesn't answer all your questions.